

# ULTRA POMPE - GEAR PUMPS

## L SERIES

### FEATURES

Flanged mounted pump to accommodate direct couplings to B3/B14 UNEL MEC flange shape. Pumps can be bidirectional, depending on safety valve.

Complete packages available including coupling, reducer, motor, and controls. Capacities from 4 to 93 cc/rev

Pressures up to 145 psi ( 10 bar ), standard temperatures up to 428° F ( 220° C )

These pumps cannot be used to pump fluids with abrasive properties.

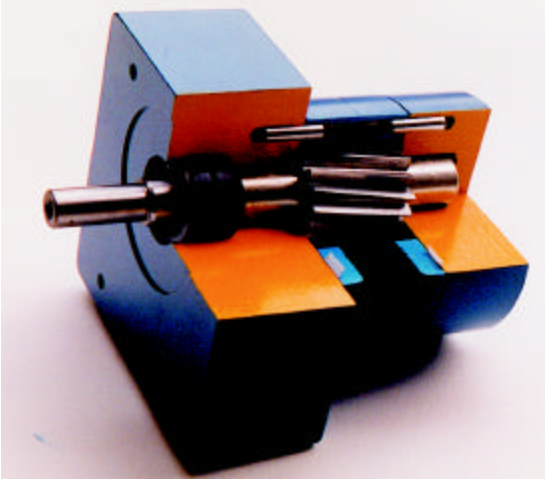

SIZE  
VOLUMETRIC DELIVERY ( cc/rev)  
MAX FLOW RATE ( l/h )  
RPM

L 4	4	360	1.500
L 6	6	540	1.500
L10	10	900	1.500
L14	14	1260	1.500
L21	21	1860	1.500
L28	28	2520	1.500
L35	35	3180	1.500
L44	44	3960	1.500
L52	52	4680	1.500
L72	72	6480	1.500
L93	93	8400	1.500

NOTE: DELIVERY, FLOW RATE AND RPM DEPENDENT ON THE FLUID CHARACTERISTICS AND OPERATING CONDITIONS

### MATERIAL TABLE:

Pump Housing: Cast iron from rolled bar  
 Gearshafts: 39 Ni Cr. Mo 3. From rolled bar ( One Piece )  
 Shaft Seal: Two Viton Lip Seal  
 Bearings: Steel-PTFE  
 Connections: Standard Threaded

Heating Jacket: Optional  
 Available Internal Safety Relief Valve

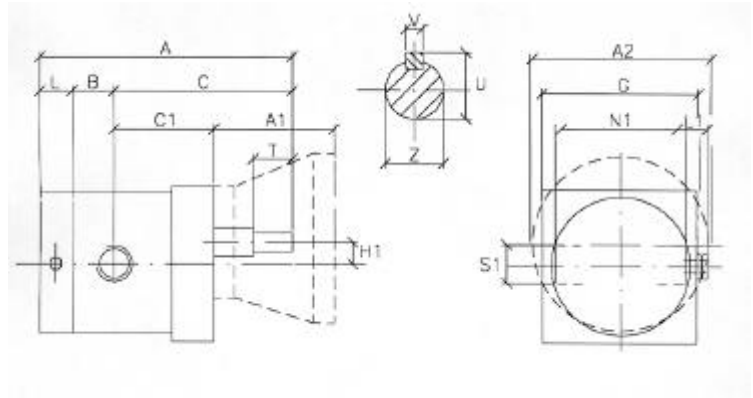

### OPERATING PARAMETERS:

VISCOSITY MIN 1 MAX 4.000 cSt  
 PRESSURE MIN 0 MAX 10 BAR  
 CAPACITY MIN 4 MAX 93 cc/rev  
 TEMPERATURE MIN -10°C MAX +240°C

CC/REV	PUMP SIZE	A	B	C	G	L	N1	S1	T	U	V	Z	H1	A1	A2	L1	C1	FRAME SIZE	Kg.
4	L4	132	33	78	80	21	80	1/4"	25	16	5	14	14	67	105	70	48	71A	5
6	L6	142	38	83	80	21	80	1/2"	25	16	5	14	14	67	105	70	53	71B	5
10	L10	158	43	94	120	21	95	1/2"	30	16	5	14	16	95	120	70	58	80A	8
14	L14	168	48	99	120	21	95	3/4"	30	16	5	14	16	95	120	70	63	80B	9
21	L21	168	45	102	120	21	110	3/4"	35	22	6	19	18	95	140	70	60	90S	11
28	L28	178	51	107	120	21	110	1"	35	22	6	19	18	95	140	70	66	90L	12
35	L35	188	56	112	120	21	110	1"	35	22	6	19	18	95	140	70	71	90L	13
44	L44	213	57	118	140	38	120	1 1/4"	40	22	6	19	20	110	160	70	72	100	15
52	L52	223	61	123	140	38	120	1 1/4"	40	22	6	19	20	110	160	70	77	100	16
72	L72	244	72	132	140	40	140	1 1/2"	40	27	8	24	24	110	160	70	90	112	19
93	L93	264	82	142	140	40	140	1 1/2"	40	27	8	24	24	110	160	70	100	112	20

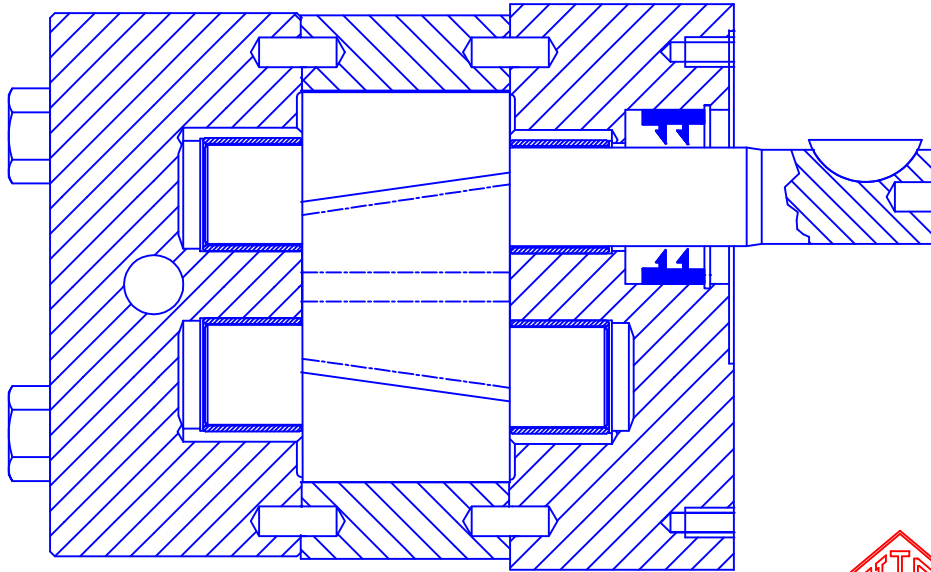

L SERIES



EXAMPLE VISCOSITY 220° CPS

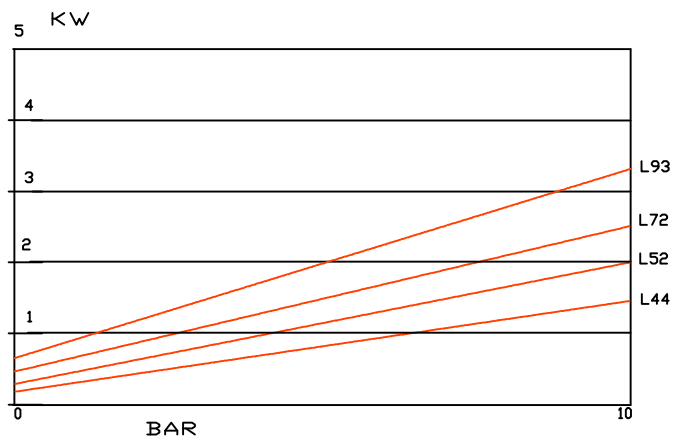
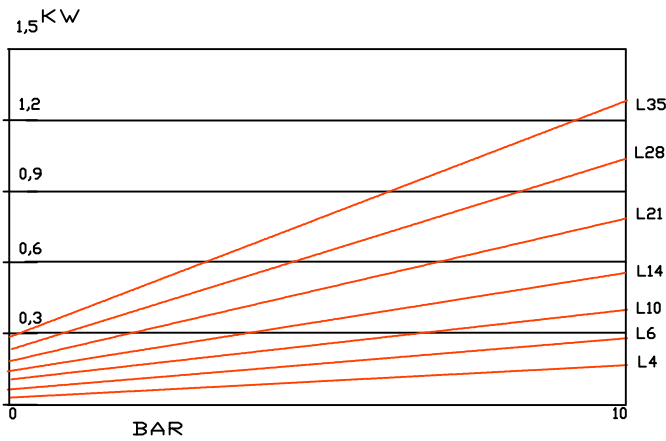
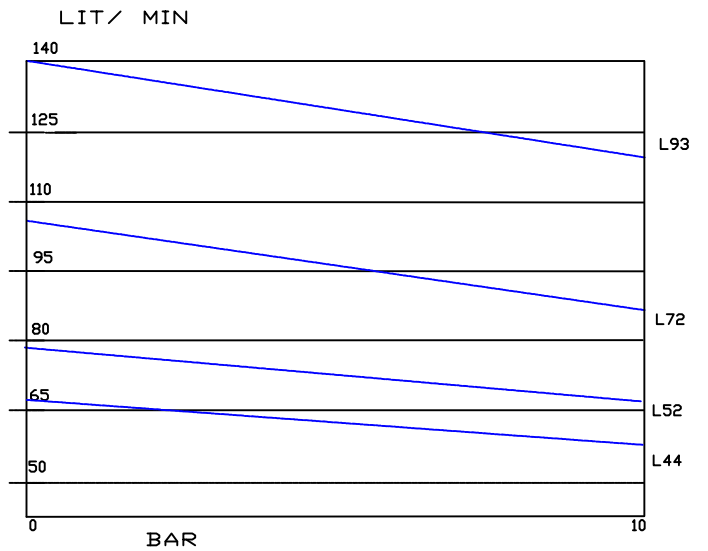
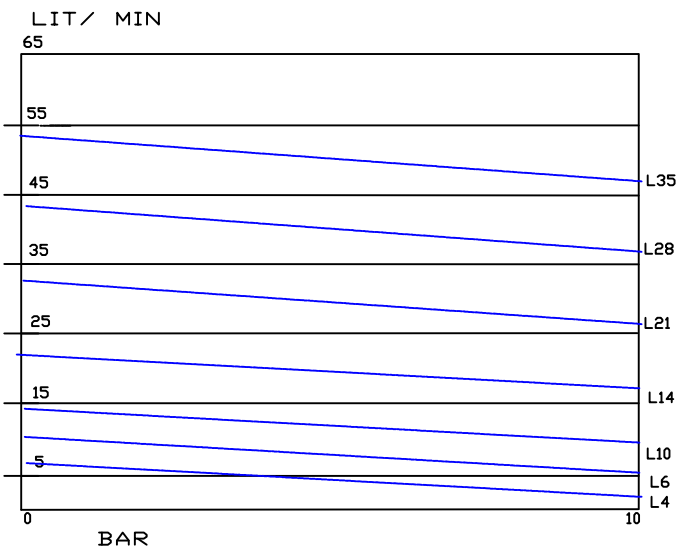

ULTRA POMPE srl - Via Goldoni 37 - 20090 Trezzano S/N Milano Italia  
 Phone ++39 02 48464552 Fax ++39 02 48464544  
 WWW:ULTRAPOMPE.IT e-mail ULTRA@ULTRAPOMPE.IT